

APPENDIX A
SITE EXHIBITS, WORKSHEETS

APPENDIX B
SUB-SUMMARY, GENERAL
SUMMARY AND BID TAB

APPENDIX C
STANDARD DRAWINGS

APPENDIX D
PREVAILING WAGE RATES
PICKAWAY COUNTY, OHIO

APPENDIX C

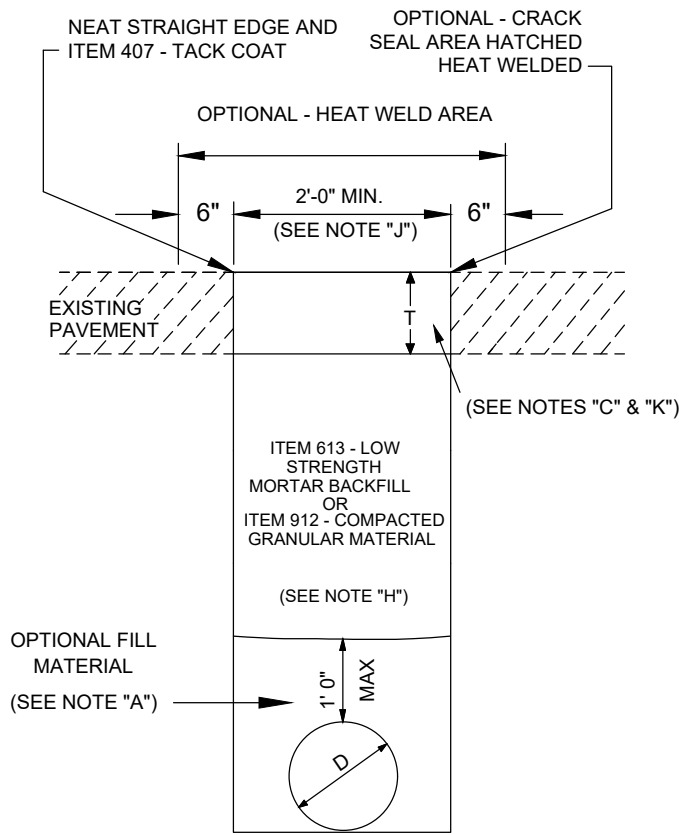

TYPE I
STANDARD FLEXIBLE ASPHALT REPAIR
 (SEE NOTES "B" & "C")

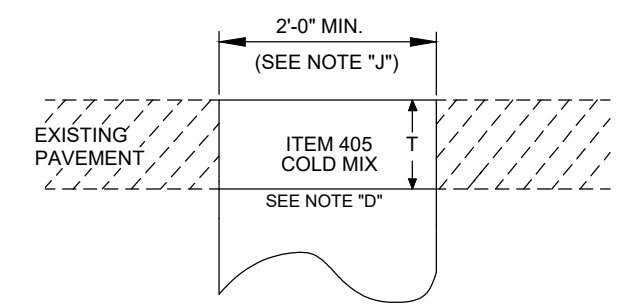

TYPE II
WINTER OPERATIONS FLEXIBLE ASPHALT REPAIR
 (SEE NOTE "E")

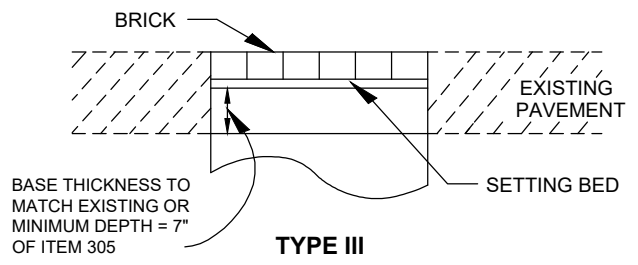

TYPE III
BRICK STREET REPAIR
 (SEE NOTE "F")

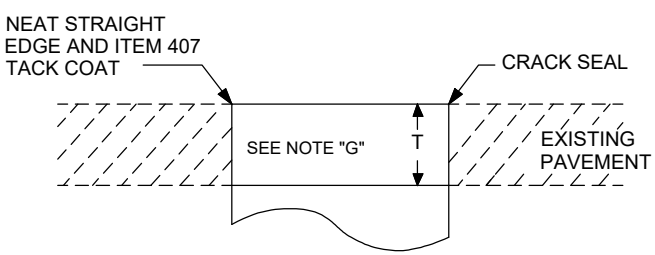

TYPE IV
ALLEY REPAIR
 (SEE NOTE "G")

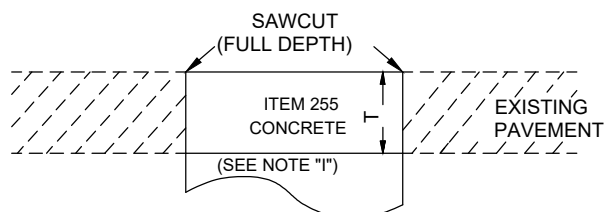

TYPE V
CONCRETE STREET REPAIR, CONCRETE BASE, CONCRETE BUS PAD OR CONCRETE PANEL REPLACEMENT
 (SEE NOTE "I")

BACKFILL FOR ALL TYPES SHALL MEET THE REQUIREMENTS SHOWN IN TYPE I ABOVE.

T: MATCH EXISTING PAVEMENT THICKNESS, HOWEVER, MINIMUM OF 10" ON ALL STREET CUTS AND 6" ON ALL ALLEYS.

PAVEMENT & UTILITY CUT REPAIR STANDARDS

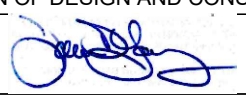
CITY OF COLUMBUS, OHIO DEPARTMENT OF PUBLIC SERVICE DIVISION OF DESIGN AND CONSTRUCTION	STD DWG 1441
	07/01/2022
CITY ENGINEER	SHT 1 OF 13

SIDEWALK AND CURB REPAIR DETAILS

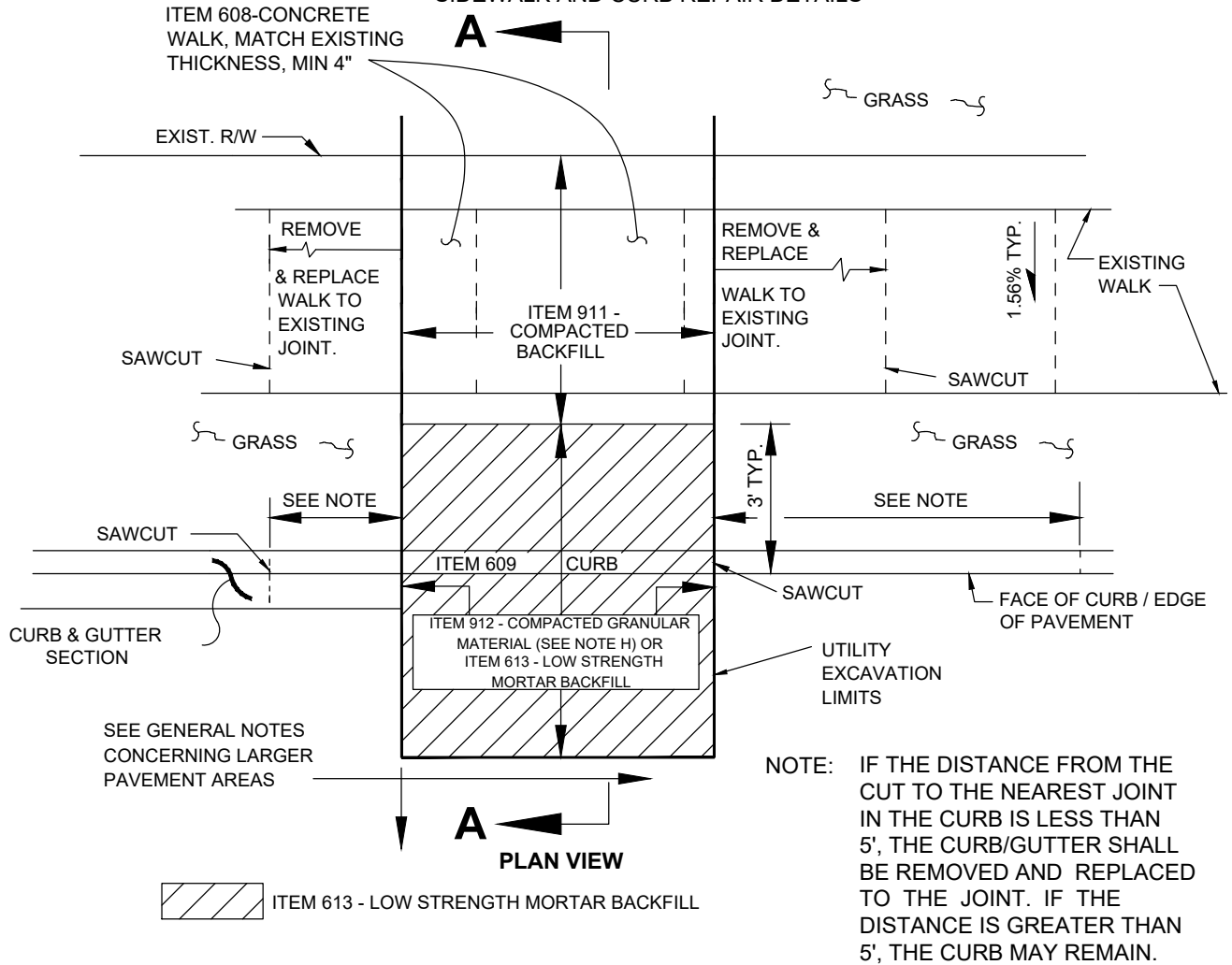

SECTION A-A

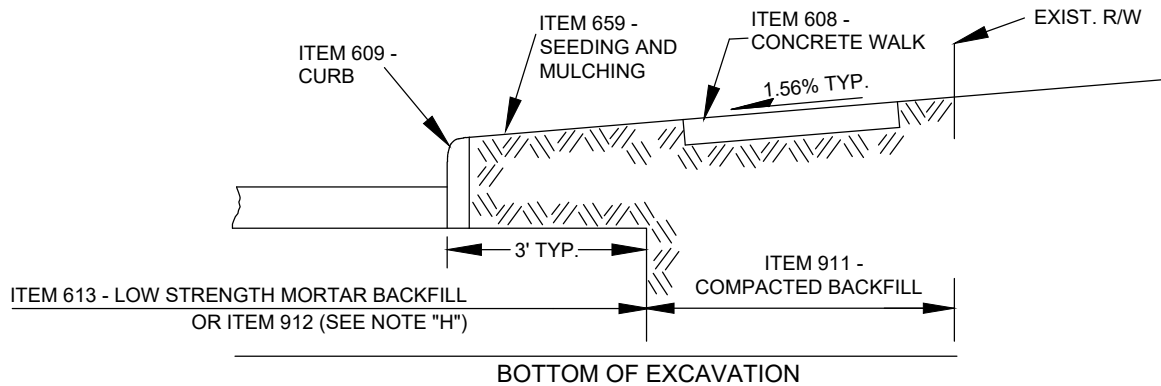

ALL GRASS AREAS SHALL BE SEEDED IN ACCORDANCE WITH ITEM 659 - SEEDING AND MULCHING.

**PAVEMENT & UTILITY
CUT REPAIR
STANDARDS**

CITY OF COLUMBUS, OHIO
DEPARTMENT OF PUBLIC SERVICE
DIVISION OF DESIGN AND CONSTRUCTION

STD DWG

1441

07/01/2022

SHT 2 OF 13

GENERAL NOTES

EXCAVATION PERMIT REQUIRED: A CITY OF COLUMBUS STREET EXCAVATION PERMIT IS REQUIRED FOR ALL EXCAVATIONS WITHIN THE PUBLIC RIGHT-OF-WAY, AS SET FORTH BY COLUMBUS CITY CODE, CHAPTER 903 AND ISSUED IN ACCORDANCE WITH PROVISIONS IN THE GENERAL RULES AND REGULATIONS OF THE DEPARTMENT OF PUBLIC SERVICE (DPS).

SCOPE OF WORK

THE CONTRACTOR SHALL FULLY COMPLY WITH THE CITY OF COLUMBUS ADA RULES AND REGULATIONS AND THE CITY OF COLUMBUS CONSTRUCTION AND MATERIAL SPECIFICATIONS, CURRENT EDITION.

THIS WORK SHALL CONSIST OF PAVEMENT REMOVAL, NECESSARY EXCAVATION, AND PAVEMENT REPLACEMENT IN ACCORDANCE WITH THE DETAILS SHOWN HEREIN. ALL WORK AND MATERIALS SHALL CONFORM TO THE REQUIREMENTS OF THE CURRENT CITY OF COLUMBUS CONSTRUCTION AND MATERIALS SPECIFICATION (CMSC).

PROCEDURES USED FOR THE PAVEMENT REMOVAL AND REPLACEMENT SHALL NOT CAUSE SPALLING OR CRACKING OF ADJACENT PAVEMENT.

WHEN THE PAVEMENT IS REMOVED AND THE CONTRACTOR IS UNABLE TO COMPLETE THE REQUIRED REPLACEMENT IN TIME FOR IT TO BE OPENED TO TRAFFIC AS INDICATED ON THE PERMIT, THE EXCAVATION SHALL BE FILLED WITH THOROUGHLY COMPACTED ITEM 405 BITUMINOUS COLD MIX WITH A DURABLE SURFACE (OR APPROVED BITUMINOUS MATERIAL) OR PROPERLY PLATED PER CHAPTER 903 AND SHEETS 12 AND 13 OF THIS STANDARD DRAWING. THE CONTRACTOR WILL BE REQUIRED TO MAINTAIN THESE TEMPORARY MEASURES WHILE THEY ARE IN SERVICE. THE COST OF PLACING, MAINTAINING, REMOVING AND DISPOSING OF THE TEMPORARY PATCHES OR PLATES WILL BE AT THE CONTRACTOR'S EXPENSE.

WHEN ITEM 613 LOW STRENGTH MORTAR BACKFILL (LSMB) IS USED AS A BACKFILL, NO PAVEMENT SHALL BE PLACED UNTIL BLEED WATER HAS BEEN EVAPORATED FROM THE LSMB SURFACE OR HAS BEEN DRAINED OR REMOVED FROM THE SURFACE. ITEM 613 LSMB IS NOT PERMITTED AS A TEMPORARY DRIVING SURFACE OR WITHIN THE DEPTH OF THE PAVEMENT REPAIR. LSMB SHALL NOT BE PLACED HIGHER THAN THE SUBGRADE ELEVATION AND NOT EXTEND INTO THE PAVEMENT BUILD-UP.

THE PAVEMENT REPAIR SHALL BE PERFORMED BY THE CONTRACTOR OR PERMITTEE IN ACCORDANCE WITH CITY SPECIFICATIONS. IF DESIRED, ANY OR ALL OF THIS WORK CAN BE PERFORMED BY THE CITY OF COLUMBUS. THE CITY SHALL COLLECT APPROPRIATE FEES AT THE TIME THE PERMIT IS ISSUED FOR SAID WORK. PAVEMENT RESTORATION MAY TRIGGER REQUIRED ADA IMPROVEMENTS PER CITY OF COLUMBUS ADA RULES AND REGULATIONS.

RESTORATION OF ANY SIDEWALK, CURB, STREET PAVEMENT (INCLUDING CRACK SEAL OR HEAT WELDING) ECT., AND INCLUDING BUT NOT LIMITED TO IN-STREET TRAFFIC CONTROL DEVICES SUCH AS REBOUNDABLE PYLONS, LONGITUDINAL CHANNELIZERS, RAISED PAVEMENT MARKERS, TRAFFIC CONTROL DEVICES SUCH AS SPEED HUMPS, RUMBLE STRIPS OR OTHER RAISED PAVEMENT TRAFFIC CALMING DEVICES SHALL OCCUR NO LATER THAN 30 DAYS AFTER CONCLUSION OF ANY UTILITY REPAIR OR INSTALLATION ACTIVITY. CONSTRUCTION ACTIVITY COMPLETED DECEMBER THROUGH APRIL SHALL BE RESOLVED NO LATER THAN MAY 31ST. ADDITIONAL PERMITS SHALL NOT BE ISSUED UNTIL THE VIOLATIONS ARE CORRECTED TO THE SATISFACTION OF THE DEPARTMENT OF PUBLIC SERVICE. IN ADDITION, EACH VIOLATION MAY BE ENFORCED IN ACCORDANCE WITH SECTION 903.99 OF THE COLUMBUS CITY CODE.

PAVEMENT & UTILITY CUT REPAIR STANDARDS

CITY OF COLUMBUS, OHIO
DEPARTMENT OF PUBLIC SERVICE
DIVISION OF DESIGN AND CONSTRUCTION

STD DWG

1441

07/01/2022

SHT 3 OF 13

SCOPE OF WORK (CONTINUED FROM PREVIOUS SHEET)

CITY CHAPTER 903 - SECTION 9 - NEW PAVEMENT OR REPAVEMENT

A THREE (3) YEAR MORATORIUM SHALL BE ENFORCED FOR ALL NEW PAVEMENT OR REPAVEMENT/RESURFACING. **NO PERMIT SHALL BE GRANTED FOR THE PURPOSE OF OPENING SUCH PAVEMENT FOR A PERIOD OF NO LESS THAN THREE (3) YEARS AFTER COMPLETION**, EXCEPT FOR THE PURPOSE OF REPAIRING LEAKING PIPES OR WORK DEEMED NECESSARY BY THE DIRECTOR OF PUBLIC SERVICE, CITY ENGINEER OR DESIGNEE. EMERGENCY REPAIRS OR OPENINGS WITHIN THE THREE (3) YEAR MORATORIUM SHALL HAVE ADDITIONAL AND SPECIFIC REQUIREMENTS BEYOND THE MINIMUM REQUIREMENT OF STD DWG 1441.

SPECIAL IMPROVED STREETS

SPECIAL IMPROVED STREETS, AS APPROVED BY THE DIRECTOR OF PUBLIC SERVICE, CITY ENGINEER OR DESIGNEE SHALL HAVE FIVE (5) YEAR MORATORIUM. NO PERMIT SHALL BE GRANTED FOR THE PURPOSE TO MAKE ANY OPENING ON ANY HARD SURFACE AREAS SUCH AS PAVEMENT, SIDEWALK, CURB, ETC., WITHIN THE RIGHT OF WAY OF SPECIAL IMPROVED STREET FOR A PERIOD OF NO LESS THAN FIVE (5) YEARS AFTER COMPLETION OF SUCH HARD SURFACE AREA. EMERGENCY REPAIRS OR PAVEMENT OPENINGS WITHIN THE FIVE (5) MORATORIUM SHALL HAVE ADDITIONAL AND SPECIFIC REQUIREMENTS BEYOND THE MINIMUM REQUIREMENTS OF STD DWG 1441 AND APPROVED ONLY BY THE DIRECTOR OF THE PUBLIC SERVICE AND CITY ENGINEER OR DESIGNEE.

CURB RAMP INSTALLATION

ALL CURB RAMPS SHALL BE INSTALLED PER STANDARD DRAWINGS 2300, 2319 AND DPS ADA RULES AND REGULATIONS.

SPECIAL PAVEMENT, BASE, AND STORMWATER BMPS

WHEN PAVEMENT CUTS OR REPAIRS IMPACT NON-CONVENTIONAL PAVEMENT BUILDUPS, THE CITY ENGINEER OR DESIGNEE WILL PROVIDE DIRECTION ON THE REQUIRED RESTORATION. IF THE NON-CONVENTIONAL PAVEMENT IS NOT IDENTIFIED IN THE DESIGN STAGE, IT IS THE PERMIT HOLDER'S RESPONSIBILITY TO BRING THIS TO THE ATTENTION OF THE DEPARTMENT OF PUBLIC SERVICE. SOME EXAMPLES OF NON-CONVENTIONAL PAVEMENT INCLUDE, FABRICS AND GRIDS USED TO STABILIZE SUBGRADE AND PAVEMENT, SPECIALITY BACKFILL AND SOIL SUPPORT STRUCTURES, PERMEABLE PAVEMENT AND STORMWATER BEST MANAGEMENT PRACTICES (BMPS).

TRAFFIC CONTROL

WHEN PAVEMENT CUTS OR REPAIRS REMOVE EXISTING STRIPING OR OTHERWISE RENDER STRIPING UNSERVICEABLE AS DETERMINED BY THE ENGINEER, TEMPORARY PAVEMENT MARKINGS PER CMSC 614 SHALL APPLY. TEMPORARY CLASS II MARKINGS SHALL BE PLACED IMMEDIATELY. CLASS II MARKINGS ARE ONLY FOR LANE LINES, CENTERLINES AND GORE MARKINGS AND PLACED FOR A MAXIMUM OF 14 DAYS. ALL TEMPORARY MARKINGS PLACED FOR A PERIOD LONGER THAN 14 DAYS BUT LESS THAN 30 DAYS SHALL BE ITEM 642 CLASS III MARKINGS. PERMANENT THERMOPLASTIC OR SPRAY THERMOPLASTIC SHALL BE PLACED WITHIN 30 DAYS ON A SURFACE COURSE. WHEN THERMOPLASTIC OR SPRAY THERMOPLASTIC IS TO BE INSTALLED, TEMPORARY MARKINGS SHALL BE CLASS III. ALL OVER WINTER TEMPORARY MARKINGS SHALL BE TYPE 1. ALL TEMPORARY PAVEMENT MARKINGS ON CONCRETE SHALL BE AS PER 740.06, TYPE I. PERMANENT PAVEMENT MARKINGS ON CONCRETE SHALL MATCH THE EXISTING PAVEMENT MARKINGS DIRECTED BY THE ENGINEER.

PAVEMENT & UTILITY CUT REPAIR STANDARDS

CITY OF COLUMBUS, OHIO
DEPARTMENT OF PUBLIC SERVICE
DIVISION OF DESIGN AND CONSTRUCTION

STD DWG

1441

07/01/2022

SHT 4 OF 13

SPECIAL NOTES

NOTE 'A' : LOW STRENGTH MORTAR BACKFILL (LSMB)

WHEN USING LOW STRENGTH MORTAR BACKFILL (LSMB), THE OPTIONAL FILL AREA OVER THE CONDUIT MAY BE BACKFILLED WITH SAND, GRANULAR MATERIAL, OR OTHER SUITABLE 912 MATERIAL, FOR A DISTANCE NOT TO EXCEED 1 FT. A PROTECTIVE BARRIER OF VISQUEEN OR SIMILAR MATERIAL IS PERMITTED.

NOTE 'B' : TYPE 1 PAVEMENT REPAIR SEALING

FOR TYPE I PAVEMENT REPAIR SEALING OPTIONS - THE FOLLOWING METHODS ARE PERMITTED:

1. CRACK SEALING METHOD: SEAL THE PERIMETER SURFACE OF THE REPAIRED AREA BY APPLYING A NOMINAL 4 INCH STRIP OF APPROVED ITEM 423 - CRACK SEALING, TYPE II OR III.
2. HEAT WELD METHOD: FOR PAVEMENT REPAIR LOCATIONS, THE AREA TO BE HEAT WELDED IS TO INCLUDE THE CUT AND EXTEND FOR 6 INCHES BEYOND EACH SIDE OF THE CUT FOR A NOMINAL DEPTH OF 2 INCHES.

NOTE 'C' : TYPE 1 PAVEMENT REPAIR RESURFACING (SEE SHEETS 9-11)

FOR TYPE I PAVEMENT REPAIR APPLICATIONS, THE FOLLOWING METHODS ARE PERMITTED:

1. IF LANE WIDTH TO BE RESURFACED: USE ITEM 441 ASPHALT CONCRETE, INTERMEDIATE COURSE, TYPE 2, (BINDER MATCHING SURFACE COURSE) PLACED IN LIFTS NOT EXCEEDING 3 INCHES TO REPAIR PAVEMENT TO THE SURFACE. DURING THE LATER MILL AND ASPHALT OVERLAY OPERATION, USE ITEM 441 ASPHALT CONCRETE SURFACE COURSE, TYPE 1.
2. IF NO LANE WIDTH RESURFACING: USE ITEM 441 ASPHALT CONCRETE, INTERMEDIATE COURSE, TYPE 2, PLACED IN LIFTS NOT EXCEEDING 3 INCHES AND ITEM 441 ASPHALT CONCRETE, SURFACE COURSE, TYPE 1 PLACED AT A MAXIMUM 1.5 INCH LIFT THICKNESS. THE INTERMEDIATE COURSE MATERIAL IS NOT PERMITTED AS THE FINAL SURFACE COURSE.

THE ASPHALT BINDER FOR INTERMEDIATE AND SURFACE COURSE ASPHALT SHALL BE PG 70-22 ON ARTERIAL ROADWAYS, BUS ROUTES, AND WHERE SPECIFIED BY THE PERMIT OFFICE. ALL OTHER ROADS SHALL BE PG 64-22.

FULL LANE WIDTH/COLD JOINT RESURFACING

THE INTENT OF RESURFACING FULL LANE WIDTH(S) IS TO MINIMIZE ADDING ADDITIONAL COLD JOINTS TO THE ROADWAY. IF THE UTILITY CUT OR TRENCH REPAIR REQUIRES TO MILL AND PAVE THE FULL LANE WIDTH, SEE BELOW AND EXAMPLES SHEETS 9-11, THE EXISTING JOINT SHALL BE LOCATED AND WHEN THE EXISTING JOINT IS WITHIN (2') TWO FEET OF A FULL LANE WIDTH THE PAVEMENT SHALL BE REPLACED TO THE COLD JOINT. A FULL LANE WIDTH IS CONSIDERED TO BE TO THE NEAREST LANE LINE, CHANNEL OR CENTERLINE.

TRENCHES THAT REQUIRE FULL LANE RESURFACING SHALL INCLUDE FULL LANE RESURFACING ON ALL CONNECTING TRENCHES AND ASSOCIATED VALVE OR CASTING WORK AREAS ALONG ADJACENT STREETS (UTILITY SERVICE REPAIRS SHALL BE AS PER SHEETS 9, 10 AND 11.) REGARDLESS OF THE LENGTH OF THE CONNECTING TRENCH.

WHEN AN EXCAVATION EXCEEDS 100 FT IN LENGTH, THE REPAIR SHALL INCLUDE ITEM 254 PLANING OF A FULL LANE WIDTH (OR ANY OTHER LANE WIDTH AS DIRECTED BY THE DEPARTMENT OF PUBLIC SERVICE) TO A DEPTH OF 1- 1/2 INCHES FOR THE ENTIRE LENGTH OF THE EXCAVATION. THE RESURFACING SHALL NOT INTRODUCE ANY LONGITUDINAL PAVEMENT JOINTS. WHEN RESURFACING OUTSIDE LANES, RESURFACING SHALL EXTEND TO THE FACE OF CURB OR EDGE OF PAVEMENT. IF PAVEMENT PLANING DOES NOT PROVIDE A UNIFORM PLANED SURFACE DUE TO THE EXISTING PAVEMENT CONDITION, THE DEPTH OF THE PAVEMENT REMOVAL AND RESURFACING SHALL BE ADJUSTED ACCORDINGLY. WHERE THE PROPOSED RESURFACING IS IN CLOSE PROXIMITY TO AN EXISTING LONGITUDINAL JOINT, THE RESURFACING SHALL BE EXTENDED TO MEET OR OVERLAP THAT JOINT. WHEN RESURFACING ADJOINS AN AREA WITH EXISTING OVERLAID GUTTER, THE RESURFACING SHALL EXTEND THE FULL LANE WIDTH TO THE EXISTING PAVEMENT EDGE AT THE FACE OF CURB. THE PLANED AREA SHALL BE TACKED USING ITEM 407.02 MATERIAL PRIOR TO PLACING AND COMPACTING APPROVED ASPHALT CONCRETE WITH A PAVER IN ACCORDANCE WITH CURRENT CITY STANDARD SPECIFICATIONS. ITEM 423 -CRACK SEALING, TYPE II OR III SHALL BE APPLIED TO EXPOSED JOINTS ONCE THE PAVING OPERATION HAS BEEN COMPLETED.

PAVEMENT & UTILITY CUT REPAIR STANDARDS

CITY OF COLUMBUS, OHIO
DEPARTMENT OF PUBLIC SERVICE
DIVISION OF DESIGN AND CONSTRUCTION

STD DWG

1441

07/01/2022

SHT 5 OF 13

SPECIAL NOTES

WHEN AN EXCAVATION CROSSES LANES, ALL LANES AFFECTED SHALL REQUIRE PLANING AND RESURFACING AS DESCRIBED ABOVE. THIS WORK SHALL INCLUDE ALL OF THE AFFECTED PAVEMENT AREA. WHEN EXCAVATION WORK FOR LATERALS CROSS LANES AT A FREQUENCY OF 2 OR MORE TRENCHES WITHIN 100 FT OF ROADWAY, THE REPAIR SHALL INCLUDE THE RESURFACING OF A FULL LANE WIDTH AS DESCRIBED ABOVE FOR THE AFFECTED LANES EXTENDING A MINIMUM OF 2 FT BEYOND THE LATERAL EXCAVATIONS LOCATED FARTHEST APART.

FULL LANE WIDTH RESURFACING OUTSIDE TRAVEL LANES SHALL EXTEND TO THE EDGE OF PAVEMENT FACE OF CURB UNLESS A SHOULDER WIDER THAN 4 FEET IS SEPARATED BY AN EXISTING LONGITUDINAL JOINT.

WHEN 2 OR MORE PAVEMENT REPAIRS ARE LOCATED WITHIN 100 FT OF EACH OTHER IN THE SAME LANE, THE REPAIR SHALL INCLUDE THE RESURFACING OF A FULL LANE WIDTH AS DESCRIBED ABOVE OF THE AFFECTED LANES EXTENDING A MINIMUM OF 2 FT BEYOND THE PAVEMENT REPAIRS LOCATED FARTHEST APART.

IF APPROVED BY THE CITY OF COLUMBUS, WHEN A PAVEMENT REPAIR AREA IS GREATER THAN 5 FT IN WIDTH AND/OR GREATER THAN 100 FT IN LENGTH, THE PAVEMENT REPAIR SECTION MAY CONFORM TO 3 INCHES OF ITEM 441 ASPHALT CONCRETE ON 7 INCHES OF ITEM 301 ASPHALT CONCRETE BASE (PLACED IN 2 LIFTS). LANE WIDTH RESURFACING REQUIREMENTS STILL APPLY. THIS OPTION MUST BE NOTED ON THE PERMIT APPLICATION AND APPROVED BY THE CITY OF COLUMBUS.

NOTE 'D' : TYPE II BITUMINOUS COLD MIX PLACEMENT

COLD MIX SHALL BE ITEM 405 BITUMINOUS COLD MIX OR OTHER COLD MIX APPROVED BY THE CITY OF COLUMBUS. IN LIEU OF COLD MIX, THE CONTRACTOR MAY USE STOCKPILED ITEM 441 ASPHALT CONCRETE AND REHEAT IT TO PLACE IN CUT AS TEMPORARY PAVEMENT REPAIR. TYPE II PAVEMENT REPLACEMENT SHALL CONSIST OF FULL DEPTH ITEM 405 COLD MIX FOR SMALL EXCAVATIONS.

NOTE 'E' : TYPE II TEMPORARY COLD MIX PLACEMENT

THE TEMPORARY COLD MIX IS TO BE REPLACED WITH ITEM 441 ASPHALT CONCRETE FOLLOWING PAVEMENT REPAIR PROCEDURES. THIS WORK SHALL BE PERFORMED AS SOON AS ASPHALT IS AVAILABLE.

NOTE 'F' : TYPE III REPAIR OF BRICK STREETS

1. THE CITY OF COLUMBUS MAINTAINS TWO TYPES OF BRICK STREETS: 1) HISTORICAL BRICK STREETS; AND 2) NEWER STYLE ROADWAY PAVER STREETS THAT COMPLY WITH SUPPLEMENTAL SPECIFICATION 1524. WHEN EXCAVATING AND REPAIRING BRICK STREETS, THE MATERIAL USED FOR REPLACEMENT SHALL MATCH THE EXISTING.
2. BRICKS OR PAVERS REMOVED FROM A REPAIR AREA SHALL BE STORED IN A SAFE PLACE BY THE CONTRACTOR FOR REUSE. THE CONTRACTOR SHALL BE RESPONSIBLE FOR REPLACING ANY BRICKS OR PAVERS THAT ARE STOLEN OR DAMAGED, AT NO ADDITIONAL COST TO THE CITY.
3. IF BRICKS OR PAVERS ARE SUPPLIED BY THE CONTRACTOR, THEY MUST CLOSELY MATCH THE EXISTING BRICKS OR PAVERS AND FIRST BE APPROVED BY THE CITY BEFORE THEY ARE USED. SEE THE DEPARTMENT OF PUBLIC SERVICE APPROVED PRODUCERS / PRODUCTS LISTS THAT CAN BE FOUND AT THE "DOCUMENT LIBRARY ON DEPARTMENT OF PUBLIC SERVICE WEBSITE"
4. SAW CUTTING: ALL PARTIAL BRICKS SHALL BE SAWCUT. FURTHER, NO BRICK WILL BE PERMITTED TO BE CUT, FOR REPLACEMENT, TO A LENGTH LESS THAN 1/2 ITS ORIGINAL LENGTH. THIS MAY REQUIRE SAW CUTTING OF ADJACENT UNDISTURBED BRICK(S).
5. DURING REMOVAL OF THE EXISTING BASE MATERIAL, IT SHALL BE CUT BACK TO AS NEARLY VERTICAL AS POSSIBLE. IF SHEARING OF THE ADJACENT BASE RESULTS, THE CONTRACTOR SHALL REMOVE ADDITIONAL BASE MATERIAL UNTIL A VERTICAL FACE IS ACHIEVED.

PAVEMENT & UTILITY CUT REPAIR STANDARDS

CITY OF COLUMBUS, OHIO
DEPARTMENT OF PUBLIC SERVICE
DIVISION OF DESIGN AND CONSTRUCTION

STD DWG

1441

07/01/2022

SHT 6 OF 13

SPECIAL NOTES

6. DURING INSTALLATION, THE BRICK IS TO BE RESET IN REASONABLY CLOSE CONFORMITY TO THE PATTERN OF THE EXISTING BRICK PAVEMENT ON A SETTING BED OVER ITEM 305 CONCRETE BASE. THE SETTING BED FOR HISTORICAL BRICK STREETS SHALL CONSIST OF 1 INCH OF SAND; WHEREAS, 3/4-INCH BITUMINOUS SETTING BED FOR NEWER STYLE ROADWAY PAVERS. THE CONCRETE BASE THICKNESS SHALL MATCH THE EXISTING BASE OR A MINIMUM OF 7 INCHES.
- 6A. HISTORICAL BRICKS WITHOUT SPACING LUGS: THE MAXIMUM WIDTH OF A BRICK JOINT SHALL BE 1/2 INCH. THIS RESTRICTION SHALL ALSO APPLY TO THE JOINT FORMED ADJACENT TO THE PERIMETER OF A REPAIR AREA, WHERE THE ROWS MAY NOT BE PARALLEL TO ONE ANOTHER. ALL JOINTS SHALL BE FILLED WITH POLYMERIC SAND FROM THE APPROVED MATERIALS LIST FOLLOWING MANUFACTURER'S INSTRUCTIONS. THIS MAY REQUIRE MORE THAN ONE APPLICATION. FURTHER, MECHANICAL VIBRATION WILL BE REQUIRED FOR CONSOLIDATION OF DRY MORTAR MIX.
- 6B. NEWER STYLE ROADWAY PAVERS: INSTALLATION AND MATERIALS SHALL MEET WITH THE REQUIREMENTS OF COLUMBUS SUPPLEMENTAL SPECIFICATION 1524.

PAVEMENT & UTILITY CUT REPAIR STANDARDS

CITY OF COLUMBUS, OHIO
DEPARTMENT OF PUBLIC SERVICE
DIVISION OF DESIGN AND CONSTRUCTION

STD DWG

1441

07/01/2022

SHT 7 OF 13

SPECIAL NOTES

NOTE 'G': TYPE IV ALLEY REPAIR

FOR ALLEY REPAIRS, THE PAVEMENT REPLACEMENT SHALL CONFORM TO THE TYPE AND THICKNESS OF THE EXISTING PAVEMENT. CHIP AND SEAL TYPE ALLEYS SHALL REQUIRE MATCHING THE EXISTING THICKNESS OF PAVEMENT WITH THE APPROPRIATE COMBINATION OF MATERIALS BASED ON THE SIZE OF THE EXCAVATION. THE MINIMUM PAVEMENT THICKNESS SHALL CONSIST OF 6 INCHES OF ITEM 441 ASPHALT CONCRETE. FINISHED CONCRETE PAVEMENT IS NOT PERMITTED. MATERIALS USED SHALL CONFORM TO THE REQUIREMENTS OF THE CURRENT CMSC.

IF MORE THAN 1/3 OF THE WIDTH OF AN ALLEY IS REMOVED, THE PAVEMENT SHALL BE REPLACED AS PER TYPE 1 AND THEN OVERLAYED OVER THE TOTAL WIDTH OF PAVEMENT AND LENGTH OF TRENCH.

NOTE 'H': ITEM 912 - COMPACTED GRANULAR MATERIAL

THIS METHOD OF BACKFILL CAN ONLY BE USED WITH FULL TIME CITY INSPECTION. AN INSPECTION FEE MUST BE POSTED WHEN THE PERMIT IS ISSUED.

NOTE 'I': CONCRETE BASE OR FULL DEPTH CONCRETE PAVEMENT

FULL DEPTH CONCRETE PAVEMENT

IF THE UTILITY TRENCH CUT IS WITHIN 6 FT OF A TRANSVERSE OR LONGITUDINAL JOINT, THE LIMITS OF THE REPAIR SHALL EXTEND TO THE JOINT. THIS MAY REQUIRE THE ENTIRE PANEL TO BE REPLACED. AT A MINIMUM, THE LIMITS OF THE CONCRETE REPAIR SHALL EXTEND 1 FT BEYOND THE LIMITS OF THE TRENCH.

IF MAINTENANCE OF TRAFFIC REQUIREMENTS ALLOW FOR SUFFICIENT CURING TIME SO THAT FAST SETTING CONCRETE IS NOT NEEDED, STANDARD CONCRETE BASE OR FULL DEPTH CONCRETE PAVEMENT MAY BE PLACED AS PER CMSC ITEM 255. THIS OPTION MUST BE NOTED ON THE PERMIT APPLICATION AND APPROVED BY THE CITY OF COLUMBUS. THE ENTIRE IMPACTED CONCRETE PANEL SHALL BE REPLACED WHEN THE UTILITY CUT IS LOCATED IN THE DOWNTOWN BUSINESS DISTRICT.

PAVEMENT WITH A CONCRETE BASE THE NEW CONCRETE BASE THICKNESS SHALL MATCH THE EXISTING (7 INCHES MINIMUM) AND IT SHALL BE PLACED TO THE LEVEL OF THE ADJACENT CONCRETE BASE WITH 1-1/2 INCHES OF ITEM 441 ASPHALT CONCRETE OVERLAY. LANE WIDTH RESURFACING REQUIREMENTS OF TYPE 1 STILL APPLY.

NOTE 'J': MINIMUM TRENCH RESTORATION WIDTH

THE TRENCH WIDTH FOR SMALL PIPES AND CONDUITS SHALL BE OF SUFFICIENT WIDTH TO ALLOW FOR THE PROPER PLACEMENT OF THE BACKFILL MATERIAL. THE PAVEMENT PORTION OF THE TRENCH SHALL BE A MINIMUM OF 2 FT IN WIDTH. THIS IS TO ALLOW FOR THE PROPER COMPACTION OF THE ASPHALT PAVEMENT. IF THE TRENCH FOR PLACING CONDUIT IS NARROWER THAN 2 FT THEN THE PAVEMENT PORTION SHALL BE CUT BACK TO PROVIDE THE 2 FT MINIMUM FOR PAVING OPERATIONS.

NOTE 'K': TEMPORARY CONCRETE PAVEMENT

CONCRETE MAY BE USED AS A PAVEMENT REPAIR OPTION AND A TEMPORARY PAVEMENT SURFACE FOR TYPE 1 PAVEMENT REPAIR IF APPROVED BY THE CITY. THE CONCRETE SHALL BE PLACED PER CMSC ITEM 255 AND FOLLOW THE REQUIREMENTS OF TYPE V PAVEMENT REPAIR. 1-1/2 INCHES OF ITEM 441 ASPHALT OVERLAY WILL BE REQUIRED OVER THE CONCRETE WHEN WORK IS COMPLETED. THIS OPTION MUST BE NOTED ON THE PERMIT APPLICATION APPROVED BY THE CITY OF COLUMBUS.

NOTE 'L': SURFACE REPAIR SHAPE (SEE SHEET 11)

THE SURFACE REPAIR OF ALL IRREGULAR-SHAPED EXCAVATIONS SHALL ALWAYS BE A RECTANGLE WITH PARALLEL SIDES THAT ARE PERPENDICULAR TO THE DIRECTION OF TRAVEL OF THE ROADWAY.

PAVEMENT & UTILITY CUT REPAIR STANDARDS

CITY OF COLUMBUS, OHIO
DEPARTMENT OF PUBLIC SERVICE
DIVISION OF DESIGN AND CONSTRUCTION

STD DWG

1441

07/01/2022

SHT 8 OF 13

ACCEPTABLE UTILITY CUT REPAIRS

EXCAVATION EXCEEDING 100' IN LENGTH LOCATED WITHIN LANE

WHEN AN EXCAVATION EXCEEDS 100 FT IN LENGTH, THE REPAIR SHALL INCLUDE ITEM 254 PAVEMENT PLANING OF A FULL LANE WIDTH (OR ANY OTHER LANE WIDTH AS DIRECTED BY THE DEPARTMENT OF PUBLIC SERVICE) TO A DEPTH OF 1-1/2 INCHES FOR THE ENTIRE LENGTH OF THE EXCAVATION. THE PLANED AREA SHALL BE THOROUGHLY CLEANED AND DRY, THEN TACKED USING ITEM 407 TACK COAT MATERIAL PRIOR TO PLACING AND COMPACTING APPROVED ASPHALT CONCRETE WITH A PAVER IN ACCORDANCE WITH CURRENT CITY STANDARD SPECIFICATIONS. ITEM 423 CRACK SEALING, TYPE II OR III, SHALL BE APPLIED TO EXPOSED JOINTS ONCE THE PAVING OPERATION HAS BEEN COMPLETED.

NOT ACCEPTABLE

SEE NOTE "C"

ACCEPTABLE

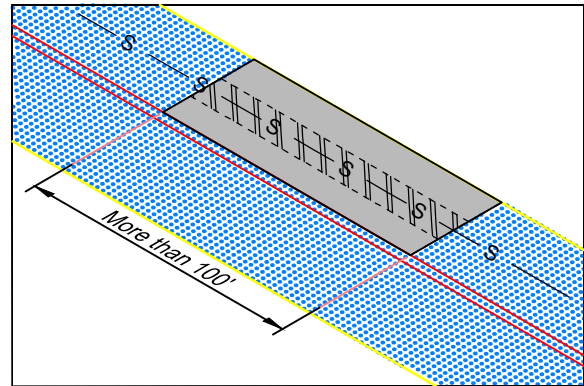
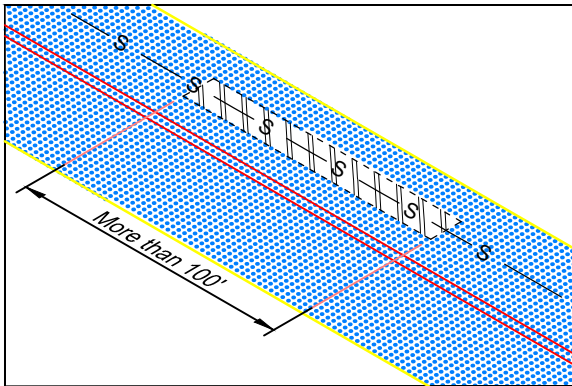

FOR AN EXCAVATION IN A SINGLE LANE, PERFORM A FULL-LANE-WIDTH PLANE AND REPAIR.

EXCAVATION EXCEEDING 100' IN LENGTH BETWEEN OR CROSSING LANES

WHEN AN EXCAVATION CROSSES LANES, ALL AFFECTED LANES SHALL REQUIRE PLANING AND RESURFACING AS DESCRIBED ABOVE. THIS WORK SHALL INCLUDE ALL OF THE PAVEMENT AREA WITHIN THE FULL WIDTH OF THE AFFECTED LANE(S) FOR THE LIMITS OF THE EXCAVATION.

NOT ACCEPTABLE

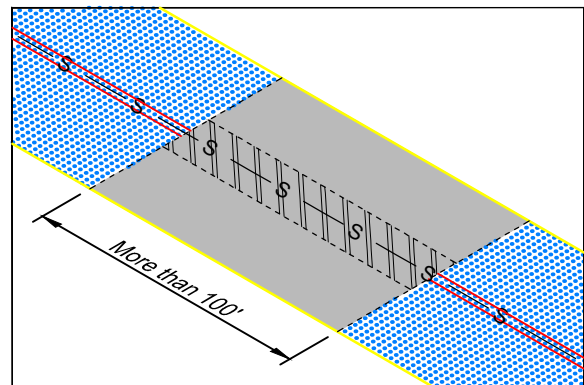
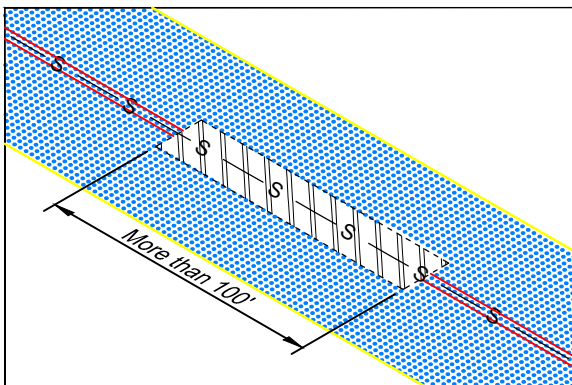

SEE NOTE "C"

ACCEPTABLE



FOR AN EXCAVATION IN MULTIPLE LANES, PERFORM A FULL-LANE-WIDTH PLANE AND REPAIR FOR ALL IMPACTED LANES.

LEGEND

-  EXISTING PAVEMENT
-  FULL DEPTH REPAIR
-  MILL/PAVE

NOTE:
EXCAVATIONS ARE CONCEPTUAL ONLY. SEE DETAILED CROSS SECTION AND PROFILE SHEETS FOR CONSTRUCTION PROCEDURES AND WIDTHS.

PAVEMENT & UTILITY CUT REPAIR STANDARDS

CITY OF COLUMBUS, OHIO
DEPARTMENT OF PUBLIC SERVICE
DIVISION OF DESIGN AND CONSTRUCTION

STD DWG

1441

07/01/2022

SHT 9 OF 13

ACCEPTABLE UTILITY CUT REPAIRS

UTILITY EXCAVATIONS CROSSING ONE LANE WITHIN 100'

WHEN EXCAVATION WORK FOR LATERALS CROSSES A LANE AT A FREQUENCY OF 2 OR MORE LATERAL EXCAVATIONS WITHIN 100 FEET OF EACH OTHER, THE REPAIR SHALL INCLUDE ITEM 254 PAVEMENT PLANING FOR THE FULL LANE WIDTH TO A DEPTH OF 1- 1/2 INCHES AND FOR A MINIMUM OF 2 FEET BEYOND THE FURTHEST LATERAL EXCAVATIONS. THE PLANED AREA SHALL BE THOROUGHLY CLEANED AND DRY, THEN TACKED USING ITEM 407 TACK COAT MATERIAL PRIOR TO PLACING AND COMPACTING APPROVED ASPHALT CONCRETE WITH A PAVER IN ACCORDANCE WITH CURRENT CITY STANDARD SPECIFICATIONS. ITEM 423 CRACK SEALING, TYPE II OR III, SHALL BE APPLIED TO EXPOSED JOINTS ONCE THE PAVING OPERATION HAS BEEN COMPLETED.

SEE NOTE "C"

NOT ACCEPTABLE

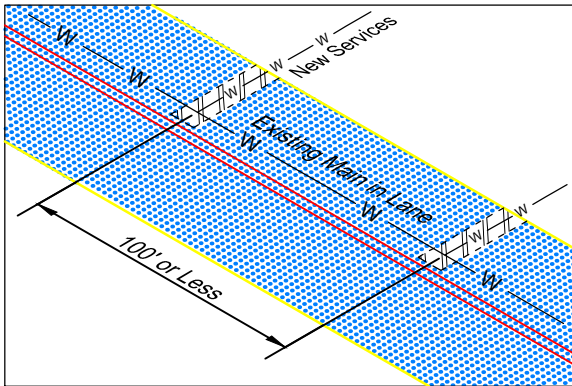

ACCEPTABLE

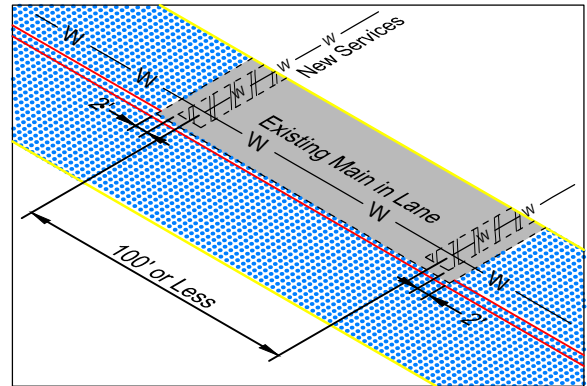

FOR MULTIPLE EXCAVATIONS WITHIN 100', PERFORM A FULL-LANE-WIDTH PLANE AND REPAIR.

UTILITY EXCAVATIONS CROSSING MULTIPLE LANES WITHIN 100'

WHEN EXCAVATION WORK CROSSES MULTIPLE LANES, ALL AFFECTED LANES SHALL REQUIRE PLANING AND RESURFACING AS DESCRIBED ABOVE. THIS WORK SHALL INCLUDE ALL OF THE PAVEMENT AREA WITHIN THE AFFECTED LANES FOR THE LIMITS OF THE LATERAL EXCAVATIONS.

SEE NOTE "C"

NOT ACCEPTABLE

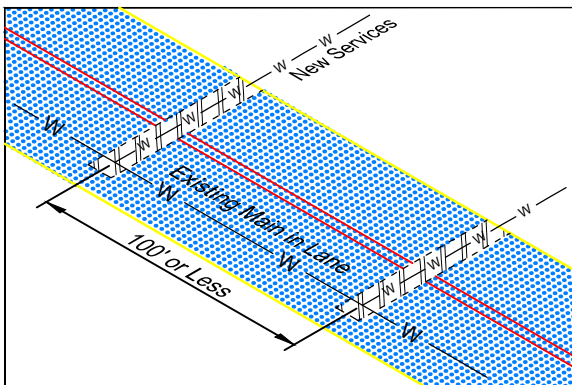

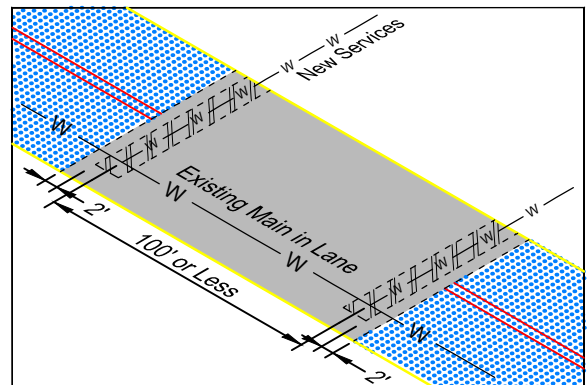

ACCEPTABLE



FOR MULTIPLE EXCAVATIONS WITHIN 100' IN MULTIPLE LANES, PERFORM A FULL-LANE-WIDTH PLANE AND REPAIR FOR ALL IMPACTED LANES.

LEGEND

-  EXISTING PAVEMENT
-  FULL DEPTH REPAIR
-  MILL/PAVE

NOTE:
EXCAVATIONS ARE CONCEPTUAL ONLY. SEE DETAILED CROSS SECTION AND PROFILE SHEETS FOR CONSTRUCTION PROCEDURES AND WIDTHS.

PAVEMENT & UTILITY CUT REPAIR STANDARDS

CITY OF COLUMBUS, OHIO
DEPARTMENT OF PUBLIC SERVICE
DIVISION OF DESIGN AND CONSTRUCTION

STD DWG

1441

07/01/2022

SHT 10 OF 13

ACCEPTABLE UTILITY CUT REPAIRS

SEE NOTE "C"

NOT ACCEPTABLE

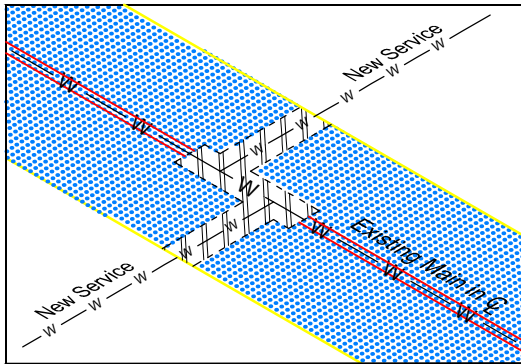

ACCEPTABLE

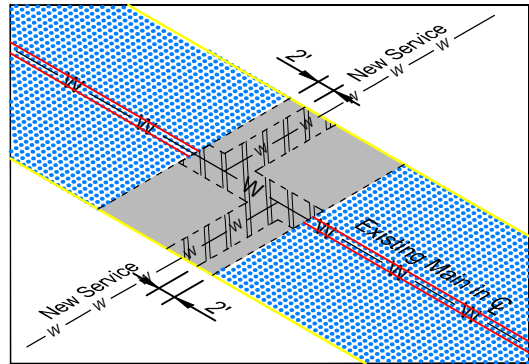

IRREGULAR SHAPES - SEE NOTE "L"

NOT ACCEPTABLE

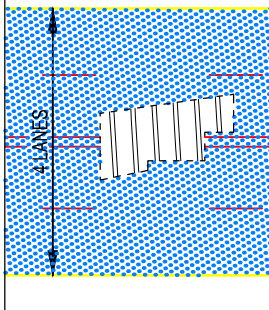

ACCEPTABLE

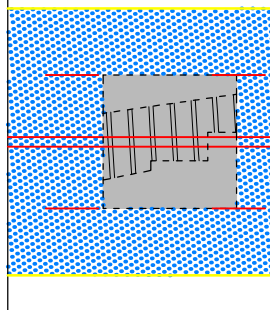

NOT ACCEPTABLE

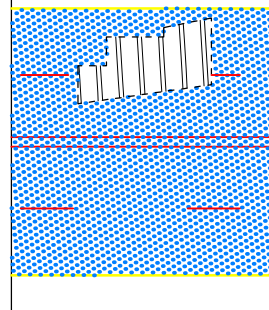

ACCEPTABLE

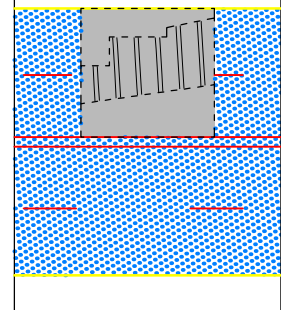

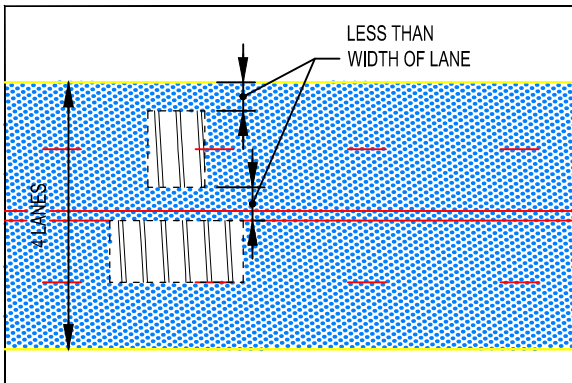

NOT ACCEPTABLE

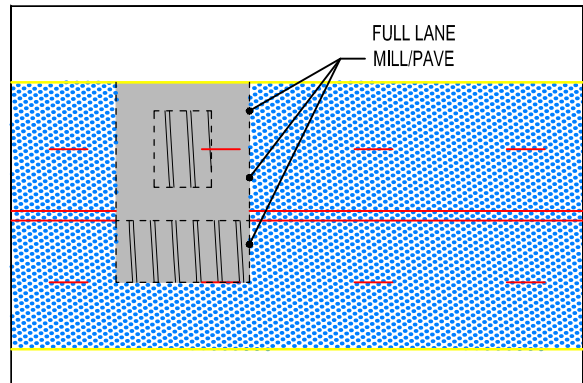

ACCEPTABLE



LEGEND

-  EXISTING PAVEMENT
-  FULL DEPTH REPAIR
-  MILL/PAVE

NOTE:
EXCAVATIONS ARE CONCEPTUAL ONLY. SEE DETAILED CROSS SECTION AND PROFILE SHEETS FOR CONSTRUCTION PROCEDURES AND WIDTHS.

PAVEMENT & UTILITY CUT REPAIR STANDARDS

CITY OF COLUMBUS, OHIO
DEPARTMENT OF PUBLIC SERVICE
DIVISION OF DESIGN AND CONSTRUCTION

STD DWG

1441

07/01/2022

SHT 11 OF 13

1. OWNER'S NAME.
2. A 24 HOUR EMERGENCY CONTACT PHONE NUMBER.

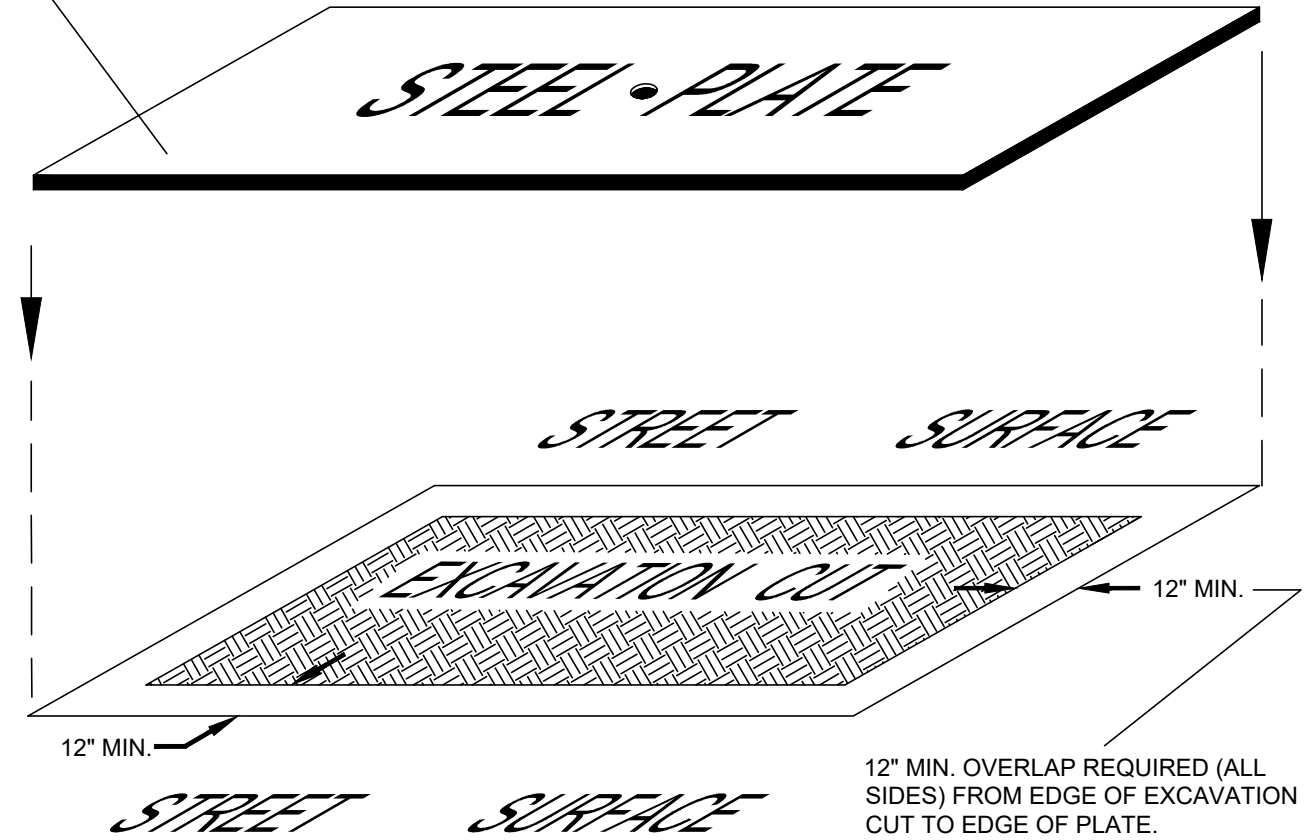

12" MIN. OVERLAP REQUIRED (ALL SIDES) FROM EDGE OF EXCAVATION CUT TO EDGE OF PLATE.

ALL STEEL PLATES MUST HAVE THE FOLLOWING INFORMATION CLEARLY AND LEGIBLY 'ETCHED' INTO THEIR TOP SURFACE:

1. OWNER'S NAME.
2. A 24 HOUR EMERGENCY CONTACT PHONE NUMBER.
3. CONTACT CITY OF COLUMBUS DIVISION OF INFRASTRUCTURE MANAGEMENT TO REPORT LOCATION OF STEEL PLATE (614) 645-5550

MINIMUM THICKNESS OF STEEL PLATES	
SIZE OF PLATE	THICKNESS
4' x 4'	1/2"
4' x 6'	3/4"
LARGER	1"

NO STEEL PINS ARE PERMITTED.

SEE SHEET 13 FOR SIGNING REQUIREMENTS.

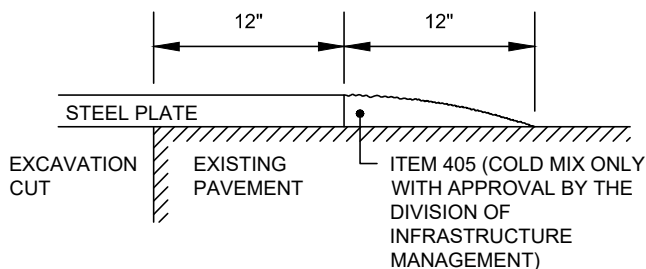

STEEL PLATE REQUIREMENTS

PAVEMENT & UTILITY CUT REPAIR STANDARDS

CITY OF COLUMBUS, OHIO
DEPARTMENT OF PUBLIC SERVICE
DIVISION OF DESIGN AND CONSTRUCTION

STD DWG

1441

07/01/2022

SHT 12 OF 13

SIGNS ARE TO BE 36"x36" FOR RESIDENTIAL AND DOWNTOWN AREAS AND 48"x48" ON MULTI-LANE, HIGH SPEED (45 MPH OR GREATER) ROADWAYS.

SIGN COC-327 (R/L) IS REQUIRED AT ALL PLATE LOCATIONS. SIGN COC-328 IS REQUIRED WHEN POSTED SPEED IS 35 MPH OR GREATER.

SIGNS SHOULD BE PLACED IN ALL DIRECTIONS THAT ARE AFFECTED. SIGN SPACING SHALL INCREASE TO 250' WHEN SPEED EXCEEDS 45 MPH.

SIGNS SHOULD BE DUAL MOUNTED ON MULTI-LANE, ONE-WAY ROADWAYS.

ALL SIGNS SHALL BE MOUNTED IN ACCORDANCE WITH THE OHIO MANUAL OF UNIFORM TRAFFIC CONTROL DEVICES (OMUTCD).

SIGNS SHALL NOT BE PLACED IN A MANNER THAT WOULD BLOCK PARKING, BIKE LANES, OR RESTRICT A PEDESTRIAN FROM USING ANY SIDEWALK INCLUDING CURB RAMPS. PAR SHALL BE MAINTAINED AT ALL TIMES.

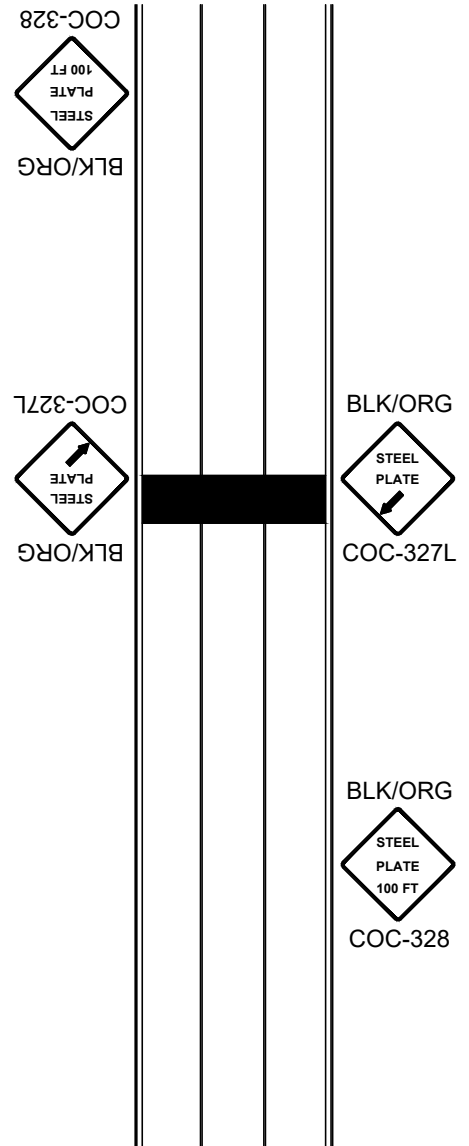

STEEL PLATE REQUIREMENTS

PAVEMENT & UTILITY CUT REPAIR STANDARDS

CITY OF COLUMBUS, OHIO
DEPARTMENT OF PUBLIC SERVICE
DIVISION OF DESIGN AND CONSTRUCTION

STD DWG

1441

07/01/2022

SHT 13 OF 13